



GATHER THESE TOOLS FOR ASSEMBLY & INSTALLATION
 7/16" wrench, 7/16" socket, 3/8" drive ratchet - 3/8" socket
 One 1/8" square end driver bit provided - Electric drill/driver/18V cordless
 One each; carpenters square, mallet, tension clamps
 One each; Phillips and blade screwdrivers, 1/2" wrench

Installation Instructions - Avalanche

1 Check contents against parts list. Examine contents for damage caused by shipping. Make sure that you have the required tools for assembly, as listed above. NOTE: Drawer Tray is assembled upside-down for ease.

2 Lay out the Drawer Side Rails with Pinch Point Sticker facing down, bearing track should be outward. NOTE: Drawer Tray is assembled upside-down and Support Rails will follow. Position the Rear Drawer Face opposite the end with the Pinch Point Stickers and use tension clamps to secure in place. (See Pic.1) Align pre-drilled holes and attach using the screws provided in Hardware Bag #1. (See Pic.1a & 1b).

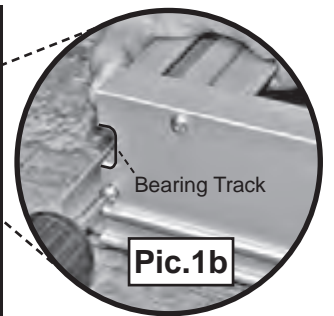

3 Starting with the Tray Cross Channel containing the Latch, loosen the nuts on the attached rail plates and insert into channel on Drawer Side Rail (See Pic.2a) and slide toward Rear Drawer Face stopping just beyond factory marks and tighten. (See Pic.2b) Latch should be located on right side of drawer. Repeat with the remaining two (2) Tray Cross Channels. (See Pic.2c)

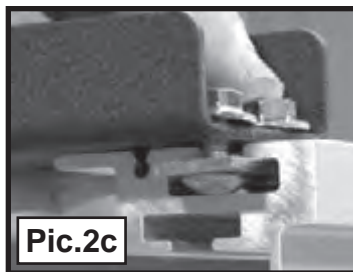
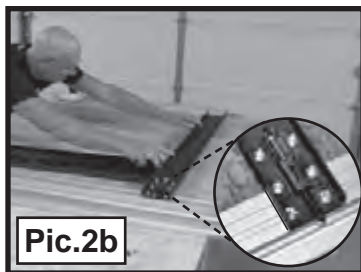
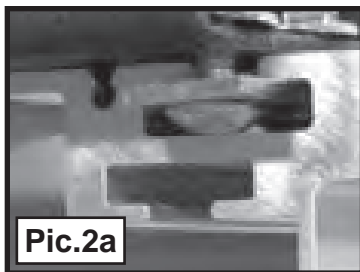

NOTE: The Latch on the Tray Cross Channel should be on your right side.

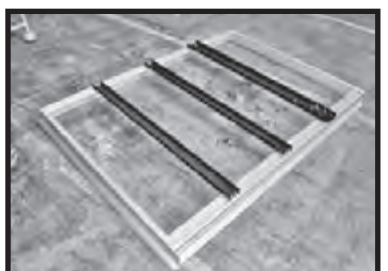

4 Attach the Drawer Pull / Face by aligning with pre-drilled holes using clamps and making sure that each Drawer Side Rail is located under the lip of the Drawer Pull / Face. (See Pic.3a) Using a electric drill/driver/18V cordless, drill screws into Drawer Pull/Face to secure. (See Pic.3b) Using ratchet and 7/16" socket, tighten the nuts on the Tray Cross Channels. Be sure to check your alignment with the factory marks. (See Pic.3c)

Questions? Contact your local dealer or try our LIVE Online Customer Support!
For additional questions call 877-455-6886 - www.jottocargoslide.com

Jotto-Cargo Slide Installation Instructions

5 Remove the E-Clip (See Pic.4) from Latch Control Cable. Insert the Latch Control Cable through pre-drilled holes in center of first two (2) Tray Cross Channels. Run the Latch Control Cable through the appropriate hole on the Tray Cross Channel w/ Latch Assembly. (See Pic.5)

6 First, insert dog leg end of latch cable into latch pin assembly; may help to push in on pin assembly. (See Pic.6) Then, push cable into tab in cross channel and snap E-clip onto notch in cable. (See Pic.7)

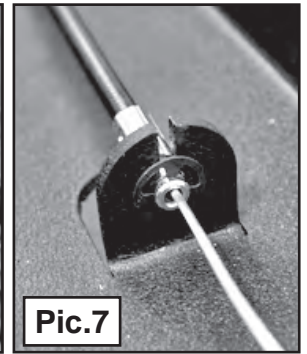
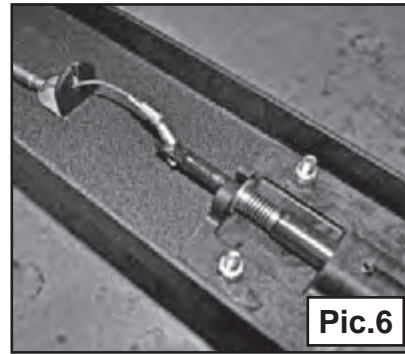
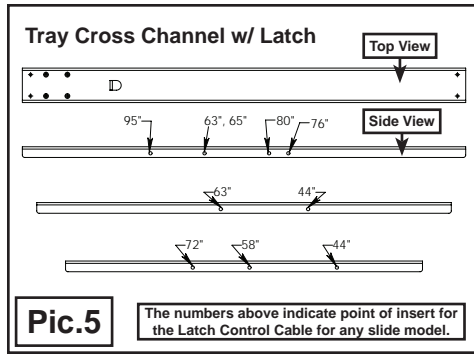

7 Insert screws and through Latch Control Cable bracket and pre-drilled holes on Drawer Pull / Face and secure with supplied Nylock Nuts using a phillips screw driver and wrench. NOTE: Nuts should attach to the bracket side. (See Pic.8 & Pic.9)

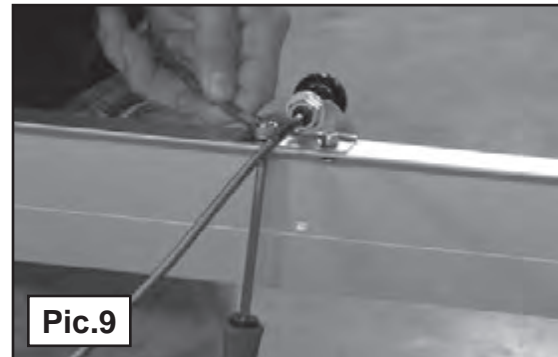

8 Once tray is assembled, slide each of the Frame Side Rails (2) into the track, channel side up. (See Pic.10) (NOTE: The latch must be disengaged to allow Frame Support Rail to slide fully into place.) With Frame Side Rails in place, slide the front Frame Support Rail with pre-attached rail plates into channel and push toward front, stopping at mark and repeat with center support. (See Pic.11)



Questions? Contact your local dealer or try our LIVE Online Customer Support!
For additional questions call 877-455-6886 - www.jottocargoslide.com

Jotto-Cargo Slide Installation Instructions

9 Now slide one (1) support bracket into each channel toward the front and stop, then slide final Frame Support Rail in place for brackets. NOTE: All three (3) Tray Cross Channels come w/ pre-drilled holes. (See Pic.12-14) Align Frame Support Rail with factory mark, and tighten the 1/4-20 flange nuts. Using an electric drill/driver/18V cordless, drive the supplied screws in Bag#1 securing slide support bracket Frame Support Rail, then tighten down the 1/4-20 flange nuts. (See Pic.15-18) Insert and carefully tighten the (2) Radial Bearings in the area located under the Front Tray Cross Channel and the Drawer Pull/Face. (See Pic.19) Tap in the provided End Caps (6) into the Tray Cross Channels. (See Pic.20)

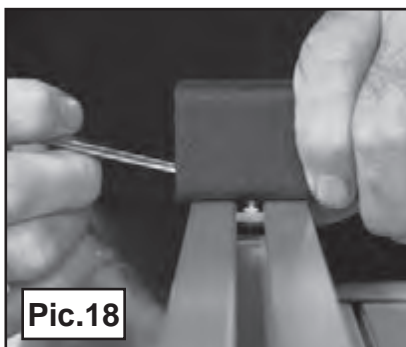

PRE-ASSEMBLY COMPLETE. PROCEED TO TRUCK BED INSTALLATION.

*Questions? Contact your local dealer or try our LIVE Online Customer Support!
For additional questions call 877-455-6886 - www.jottocargoslide.com*

Jotto-Cargo Slide Installation Instructions

NOW FOR THE COMPLETE TRUCK BED INSTALLATION.

10 With a friend, place Jotto-Cargo Slide into Avalanche Bed. (See Pic.21) Open the bed area access from the back seat area of the Avalanche. Loosen the lower tie down cap screws on either side of the bed. (See Pic.22) Slide the U Brackets onto the cap screws with the rail plates on top and tighten the cap screws to hold the U Bracket in place. (See Pic.23) Remove the rail plates from the U Brackets.

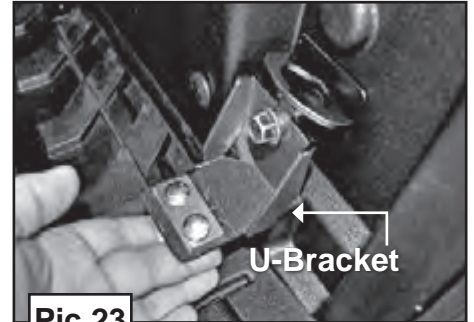
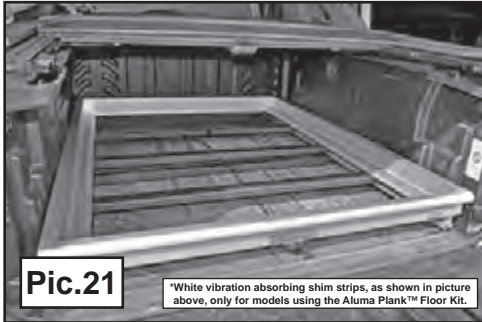

11 Adjust the location of the Cargo Slide in the Avalanche bed such that the tailgate and the bed access door will close. While sitting in the back seat area, place the rail plates into the channels on the Frame Side Rails. (You may want to extend the drawer of the Cargo Slide at this time) Slide the rails until the bolts in the rails align with the holes in the U-Brackets. Attach the bolts to the U-Brackets with the flange nuts. Tighten the tie down cap screws and the flange nuts. (See Pic.24) Now your Cargo Slide is secured and ready to use!

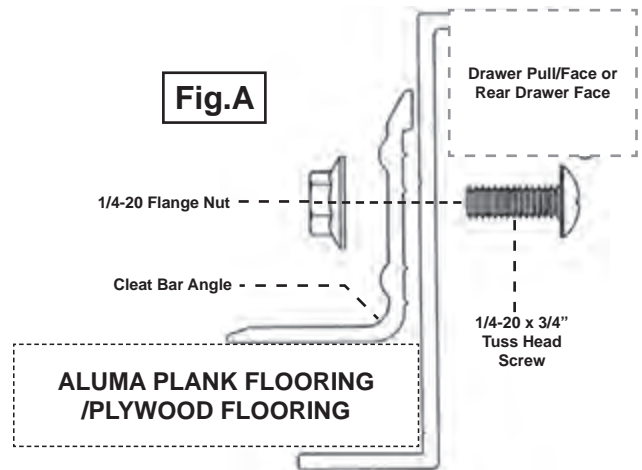
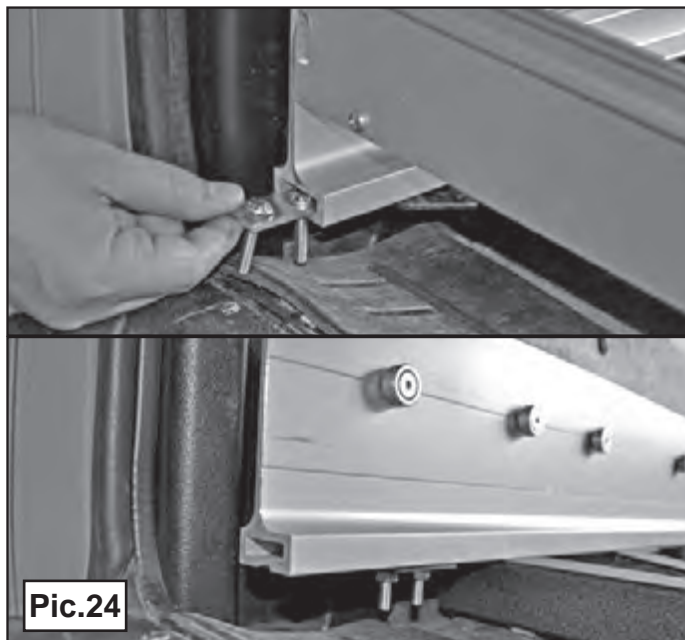

DRAWER BOTTOM - A piece of plywood 5/8" - 3/4" thick is commonly used. Cut to the size of your tray. Plywood must be cut square, either cut yourself or at your local lumber outlet.

Full Size P/U 63" X 49": CUT 60.25" X 42.50"

*NOTE: If your Jotto-Cargo Slide is overly exposed to the elements, we recommend a marine grade plywood or our optional Aluma Plank System.

----- WARNING -----
SEE WEIGHT DISTRIBUTION DIAGRAM BEFORE LOADING AND USING TRAY

NO	YES
----	-----

Please Observe & Do Not Exceed Vehicle Weight Capacity, and Use Even Distribution with Slide!

Questions? Contact your local dealer or try our LIVE Online Customer Support!
For additional questions call 877-455-6886 - www.jottocargoslide.com

Jotto-Cargo Slide Parts Assembly

HARDWARE BAGS: 1-2



BAG #1:

- (8) #10 Sheet Metal Screws
- (1) Square head bit
- (2) 1/4-1.5" Slotted Screws
- (2) 3/8" wiz flange nuts
- (2) radial bearings
- warranty card
- instruction form



BAG #2:

- (6) black cap plugs
- (1) e-clip
- (6) phillips head bolts
- (6) 1/4-20 Flange Nuts

FRAME ASSEMBLY



FRAME SIDE RAILS (2)



FRAME SUPPORT RAILS (3)



SUPPORT BRACKETS (2)

DRAWER ASSEMBLY



DRAWER SIDE RAILS (2)



DRAWER PULL / FACE



REAR DRAWER FACE

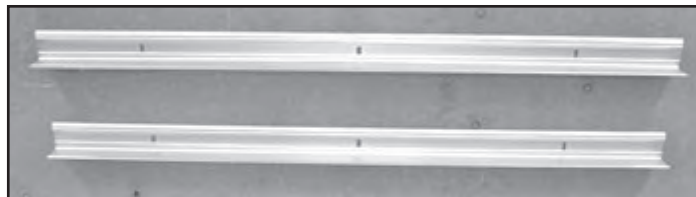

FRONT AND REAR FLOOR CLEATS (2)



TRAY CROSS CHANNELS (3)

FINAL ASSEMBLY



LATCH CONTROL CABLE



PULL HANDLE

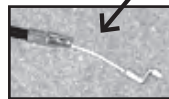

DOG LEG



RADIAL BEARINGS (2)



END CAPS (6)



U-Brackets (2) - (BAG #3)

Questions? Contact your local dealer or try our LIVE Online Customer Support!
For additional questions call 877-455-6886 - www.jottocargoslide.com